

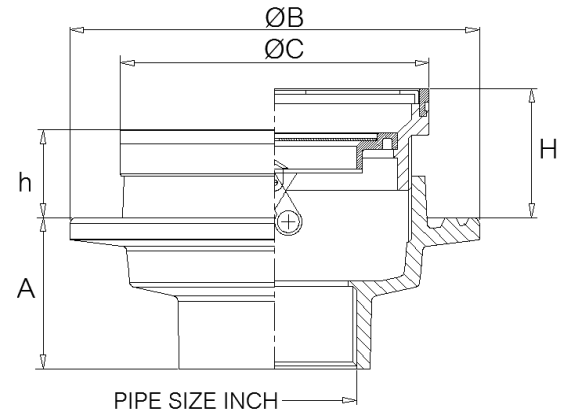

FLOOR DRAIN

RK101SGV Round flange with flashing, polished stainless steel grating. Water drain valve type.

COLOR	Black
	



Medium - heavy duty residential applications .

Furnished with ABS body and stainless steel grate. Odor protection by butterfly gravity valve. Fit for pipe $\varnothing 2''$ to $\varnothing 4''$

Pipe Size Inch	A	B	C	Adjustment	
				h	H
2	55	150	114	32	47
2.5	55	150	114	32	47
3	55	150	114	32	47
4	75	200	160	35	55

Typical installation

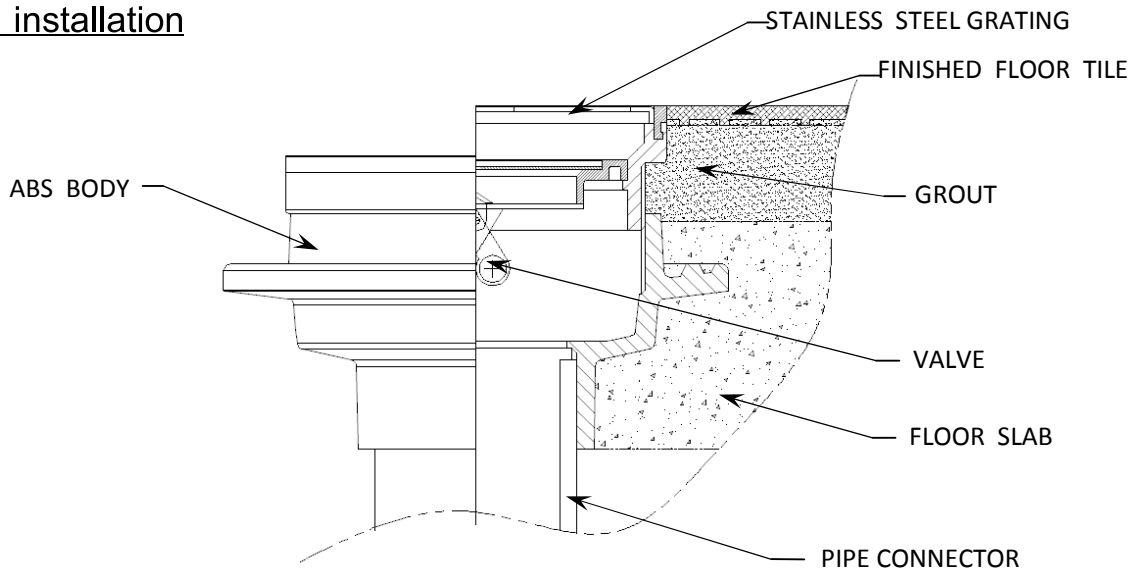

Manufacturing By : Union Precision Engineering Co.,Ltd.
 24/33 Moo 6 Bangna-Trad Rd., K.M. 24 Bangsaothong, Samuthprakarn 10540
 Distributed By : G-Plus Trading Co.,Ltd. Tel. 740-1035 www.g-plus.co.th