

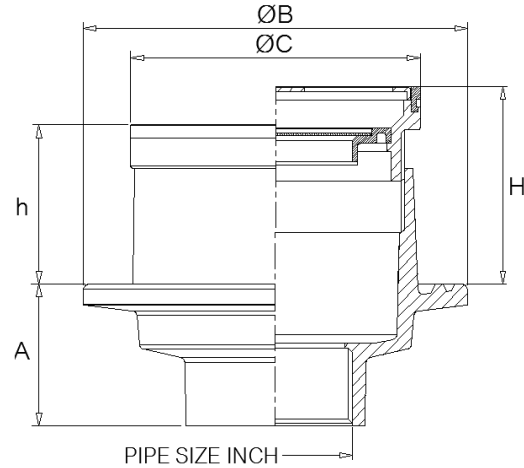

FLOOR DRAIN

RK102SGN Round flange with flashing, double stainless steel grating. Water drain freeflow type.

COLOR	Black
	



Medium - heavy duty residential applications .
Furnished with ABS body and stainless steel grate. Fit for pipe Ø2" to Ø 4"

Pipe Size Inch	A	B	C	Adjustment	
				h	H
2	55	150	114	62	77
2.5	55	150	114	62	77
3	55	150	114	62	77
4	75	200	150	65	85

Typical installation

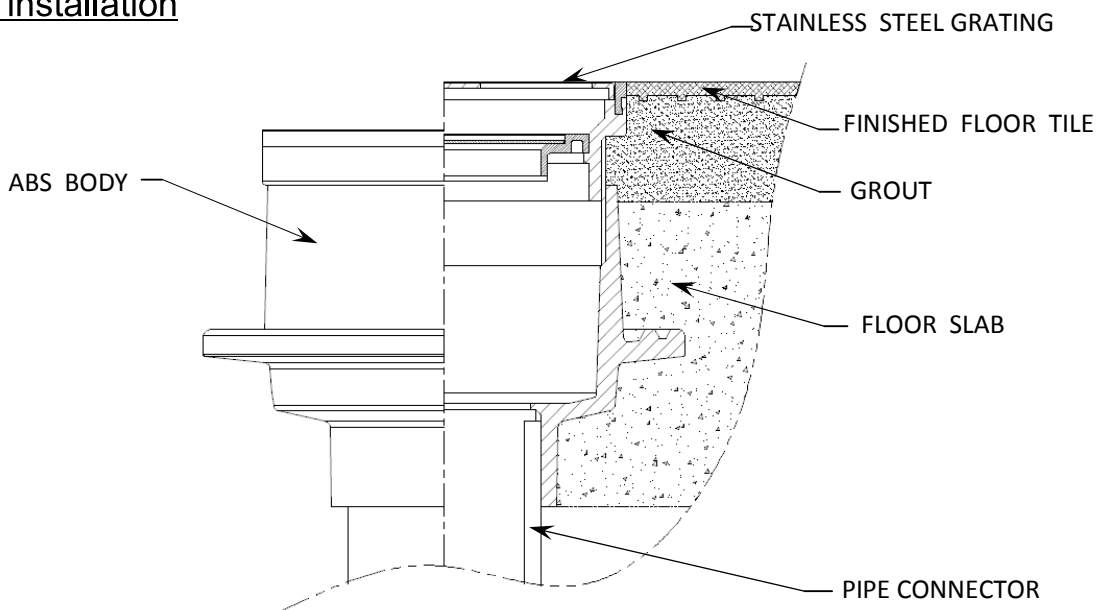

Manufacturing By : Union Precision Engineering Co.,Ltd.
24/33 Moo 6 Bangna-Trad Rd., K.M. 24 Bangsaothong, Samuthprakarn 10540
Distributed By : G-Plus Trading Co.,Ltd. Tel. 740-1035 www.g-plus.co.th